













- IT** Carcassa in alluminio anodizzato - vasca e lame estraibili in acciaio inox - coperchio superiore in policarbonato alimentare trasparente - microinterruttori di sicurezza su coperchio e vasca - capacità vasca 3-5-8 litri - dotato di coltello a 2 lame taglienti - variatore di velocità.
- EN** Anodized aluminium casing - removable stainless steel bowl and blades - upper lid in clear alimentary polycarbonate - safety microswitches on lid and bowl - bowl capacity 3-5-8 litres - equipped with a knife with 2 sharp blades - double speed.
- FR** Corps en aluminium anodisé - cuve et lames amovibles en acier Inox - couvercle supérieur en polycarbonate alimentaire transparent - microinterrupteur de sécurité sur le couvercle et la cuve - capacité cuve 3-5-8 litres - équipé d'un couteau avec 2 lames pointues - double vitesse.
- DE** Eloxiertes Aluminiumgehäuse - abnehmbare Edelstahlschüssel und -klingen - oberer Deckel aus durchsichtigem lebensmitteleuglichem Polykarbonat - Druckknopf - Sicherheitsmikroschalter am Deckel und Schüsselträgerfuß - Motorbremse - Schüsselinhalt 3-5-8 Liter - ausgestattet mit einem Messer mit 2 scharfen Klingen - doppelte Geschwindigkeit.
- ES** Carcasa de aluminio anodizado - bol y cuchillas extraíbles de acero inoxidable AISI 304 - tapa superior de policarbonato transparente para alimentos - microinterruptores de seguridad en la tapa y el bol - capacidad del bol 3-5-8 litros - dotado de cuchillo con 2 hojas cortantes. - variador de velocidad.
- RU** Корпус из анодированного алюминия - Съемная чаша и лезвия из нержавеющей стали - прозрачная верхняя крышка из поликарбоната - кнопка - предохранительный микровыключатель на крышке и опорной лапке - моторный тормоз - объем барабана 3-5-8 литров - оснащен ножом с 2 острыми лезвиями - двойная скорость.

|  | BC5NV | BC8NV |
|--|--|--------------------------------------|
|  | 0,75 kW (1 HP) | |
|  | 230V/1N/50Hz | |
|  | 260±2120 rpm | |
|  | 5 L ø 210 x 160(h) mm max. 2,8 L | 8 L ø 210 x 210(h) mm max. 4 L |
|  | 710 x 320 x 850(h) mm | 710 x 320 x 900(h) mm |
|  | | |
|  | 24 Kg | 25 Kg |
|  | 26 Kg | 27 Kg |
|  | 485 x 630 x 530(h) mm | 485 x 630 x 550(h) mm |
|  | 0,160 m³ | 0,170 m³ |
|  |  | |
| | 1250 € | 1350 € |
| Special Voltages - Разное питающее напряжение + 50 € | | |

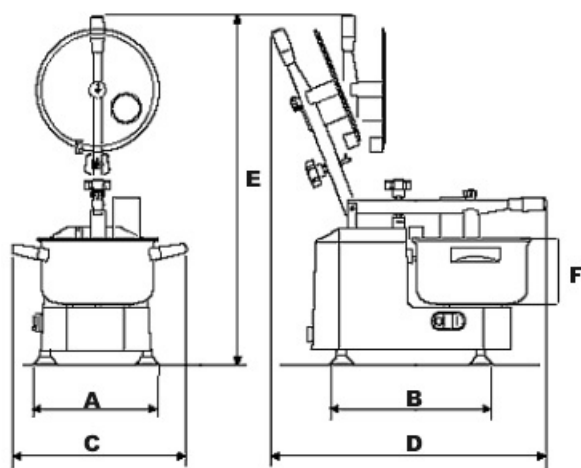

| | BC5NV | BC8NV |
|---|--------|--------|
| A | 260 mm | |
| B | 360 mm | |
| C | 320 mm | |
| D | 710 mm | |
| E | 850 mm | 900 mm |
| F | 160 mm | 210 mm |

OPTIONAL

